



# Product Catalogue and Technical Specifications

جودة وابتكار  
QUALITY WIRE PRODUCTS

Single largest source in the Middle East  
for all types of wire mesh, perforated and  
filtration products, pressure vessels internals



# Welcome

## Quality Wire Products Company

Quality Wire Products Co W.L.L is one of the single largest sources in the Middle East for supply of wire mesh related products. We offer a complete range of wire mesh and perforated sheet products which are used in the separation; insulation and industrial application.

With variety of products offered under one roof we have the pride to inform our traders/partners to open stores to stock and sell only our line of products.

With stocks and inventories of finished goods valued more than 5Million dollars and with complete line of products enclosed above we can ship a consolidated order in a container with each line of products in small quantity there by reducing the transportation/shipping cost and maintain minimum stock level at the customer stores. This concept has become very successful and with this concept we are exporting our products to more than 20 countries and we are proud to say that we have become the single largest source to supply all types of wire mesh products under one roof.

## Product Catalogue and Technical Specifications

### Quality Wire Products

Mist Eliminators	04
Wedge Wire Screens	07
Industrial Gratings	08
Tower Packings	09
Structured Packings	10
Strainers	11
Coalescers	12
Perforated Sheets	14
Wire Mesh	17
Hexagonal Pipe Winding Mesh	22

## MIST ELIMINATORS

DEMISTER PADS - MISTER SCREENS

### QWP CS TYPE (Custom Made)

On many cases Teflon, Polypropylene and Polyester mono & multifilament demisters are made upon special request from the customers. Mesh Pad Density, Surface area and free volume will be provided upon request. These type of meshes are called QWPCS Type (CS stands for Custom made)



كواليتي واير برودكس  
QUALITY WIRE PRODUCTS

QWP Mist Eliminator Specifications – Stainless Steel All Grades				
QWP Type	Density Kg/m3	Wire Surface Area m2/m3	Wire dia. mm	Free Volume%
Type : 1	75	135 to 150	0.25 to 0.28	99
Type : 2	80	142 to 160	0.25 to 0.28	99
Type : 2A	80	250 to 268	0.15 to 0.16	99
Type : 3	110	196 to 220	0.25 to 0.28	98.6
Type : 3A	110	343 to 366	0.15 to 0.16	98.6
Type : 4	128	228 to 256	0.25 to 0.28	98.4
Type : 4A	128	400 to 426	0.15 to 0.16	98.4
Type : 4B	136	228 to 256	0.25 to 0.28	98.4
Type : 4C	120	214 to 240	0.25 to 0.28	98.5
Type : 5	144	257 to 288	0.25 to 0.28	98.2
Type : 5A	150	267 to 300	0.25 to 0.28	98.125
Type : 5B	150	468 to 500	0.15 to 0.16	98.125
Type : 5B	160	285 to 3200	0.25 to 0.28	98.0
Type : 6	173	308 to 360	0.24 to 0.28	97.8
Type : 6A	175	312 to 350	0.24 to 0.28	97.8
Type : 7	193	344 to 386	0.25 to 0.28	97.58
Type : 7A	193	603 to 643	0.15 to 0.16	97.58
Type : 7B	195	348 to 390	0.25 to 0.28	97.56
Type : 7C	195	609 to 650	0.15 to 0.16	97.56
Type : 7D	191	341 to 382	0.25 to 0.28	97.62
Type : 8	214	382 to 428	0.25 to 0.30	97.325
Type : 8A	232	414 to 464	0.25 to 0.28	97.10
Type : 8B	232	414 to 464	0.25 to 0.28	97.10
Type : 9	320	888 to 950	0.17 to 0.18	96
Type : 10	350	1166 to 1300	0.135 to 0.15	95.625
Type : 11	220	910 to 920	0.12 to 0.125	97.25

QWP Mist Eliminator Specifications – Monel Grades				
QWP Type	Density Kg/m3	Wire Surface Area m2/m3	Wire dia. mm	Free Volume %
Type : 1M	80	129 to 145	0.25 to 0.28	99.10
Type : 2M	110	178 to 200	0.25 to 0.28	98.75
Type : 3M	128	207 to 232	0.25 to 0.28	98.54
Type : 4M	144	233 to 261	0.25 to 0.28	98.36
Type : 5M	173	280 to 314	0.24 to 0.28	98.03
Type : 6M	193	313 to 350	0.25 to 0.28	97.80
Type : 7M	214	355 to 389	0.25 to 0.28	97.56

Standard Grid Specifications			
Grid Specifications	Width mm	Thickness mm	Material
Flat Bar Specifications	15 to 50 MM	2.0MM to 6MM	Same as Mist Eliminator Type
Rod Specification	Round	4.0MM to 10MM	Same as Mist Eliminator Type

#### Standard Material of Construction for Mist Eliminators:

Mist Eliminators are manufactured in all grades of Stainless Steel and other special alloy like Monel; Inconel; Alloy 20; Hastelloy & Titanium.

#### Typical Mist Eliminator Fastener Details:

Tie Wire, J Bolts, I Bolts, Cleats and "L" Angles.

## MIST ELIMINATORS

VANE TYPE

5

### QWP Vane type Mist Eliminator Specifications

Qwp type	App. Density Kg/cm	Surface area S.M./cm	Voidage %	Ht (mm)	Pass No.	Hooks 10mm	Spacing mm	Sheet Thk. (mm)	F (m.K.S.) 2500 k/tv sm	Dp (mmw) For F	Approx max achievable eff.(%) For10m
V-1	136	67	98.3	210	3	No	38	0.5	3.4	14	54
V-2	184	91	97.7	210	3	Yes	38	0.5	3.4	27	72
V-3	208	103	97.4	250	4	No	25	0.5	3.4	15	69
V-3.1	204	101	97.5	190	3	No	25	0.5	3.4	13	63
V-3.2	350		69	250	4	No	25	1.0			
V-4	280	139	96.5	250	4	Yes	25	0.5	3.4	33	93
V-4.1	272	135	96.6	190	3	Yes	25	0.5	3.4	29	84
V-5	528	261	93.4	230	7	No	10	0.5	3.4	32	99
V-6	104	51	98.7	250	4	No	50	0.5	3.55	15	55
V-7	140	69	98.3	250	4	Yes	50	0.5	3.75	28	73
V-6.1	104	51	98.7	210	3	No	50	0.5	3.7	13	50
V-7.1	140	69	98.3	210	3	Yes	50	0.5	3.8	24	66
V-10	384	190	95.2	200	3	No	12.5	0.5	4.7	35	97.5
V-10.1	384	190	95.2	200	3	Yes	12.5	0.5	6.1	27	97.5

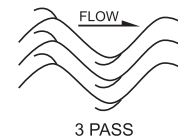

3 PASS

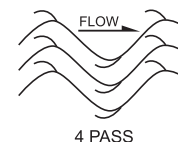

4 PASS

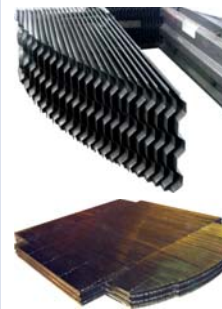

كواليتي واير برودكس  
QUALITY WIRE PRODUCTS

### RAW MATERIAL FOR VANE TYPE MIST ELIMINATORS

Stainless steel all grades	Carbon steel grade	Monel 400	Inconel all grades	Poly propylene
Teflon	Non metallic type	Alloy 625	Titanium	Hastelloy

RAW MATERIAL FOR VANE TYPE MIST ELIMINATORS				
Threaded bar from 10mm to 25mm	J bolts and I bolts	Optional perforated plates on top	m10 nuts to m25 nuts	10 mm spacers to 50mm spacers



**MIST ELIMINATOR INSTALLATION MANUAL:**

Mist Eliminator/Demister Pads are manufactured and supplied in segments with grids build over the pads. The segments are installed inside the equipments/vessel as per the drawings and we hereby provide the basic procedure for the demisters. Installation is divided into two parts whereby one is fastening method and the other is support arrangements.

**Fastening Methods:**

**1. Fastening Method -Tie Wire:**

Metal wire is supplied with the mist eliminator to secure it to the ring. This is one of the simplest and most common methods where there is a base support like angle or beam and the unit is installed from the bottom or inlet side. The above method requires holes of approximately 6MM diameter to be drilled in the support on approximately 100MM to 125MM centers. In the correct position, tie each one by four place by passing a piece of wire over the grid and through a hole into the ring. Twist the end of the tie wire and bend them to prevent injury.

**2. Fastening Method – J Bolts:**

J Bolts are also used in installations where you have immediate access to the support to the support ring Four J bolts per segment are required. The most common sizes are 6MM and 9MM. They produced a more secure support than tie wire and are typically used in applications where the installation is required to be very firm. There are two ways to use J-Bolts. They can pass directly through holes in the support ring or through a clamp that catches the support ring. In both cases the J portion of the Bolts holds to the grid and is tightened from the bottom by using nuts.

**3. Fastening Method – I Bolts:**

In some applications I-Bolt are used. "I-Bolt" assembly consists of a pipe sleeve (typically two or four per segment depending on customer request) inserted through the mist eliminator and located around the grid just above the support ring. When the segments are installed, holes are drilled over the support ring using the sleeves to mark the correct location. Specified size bolts (the I-Bolts) are installed through the pipe sleeves and supports, and fastened with two nuts.

**Support Arrangements:**

Three types of support arrangement are used most commonly depending upon the diameter or size of the mesh pad as follows.

**1. Support Systems – Support Ring:**

Two supports consist of two rings, one on either side of the mesh pad unit being installed. This is a common method to hold a mist eliminator for vertical or horizontal mesh pad locations. A two support ring arrangement has removable segments on the side of the man-way that are bolted back in place after the last mist eliminator is installed. If the diameter of the mesh pad is small then support ring in the circumference is sufficient to hold the demister. Max dia will be 1000MM whereby mist eliminator can be installed with only support ring.

**2. Angle Support:**

Angles are mostly used for holding the demisters if the diameter of the mesh pad is between 1000MM to 3000MM. Angles are welded to the vessel on top and bottom at certain intervals to hold the demister in the same level. Angle support are used along with support ring arrangements.

**3. Support Systems – I Beam:**

I-Beam, or channel, Hold-Down Beams are mostly used for installations performed from the top and they run vertical to the mist eliminator segments. Hold – Down beams can be bolted to cleats on the vessel wall just above the Mist eliminator once the unit is in place. If the diameter of the mesh pad is big say above 3000MM then apart from support ring (on the circumference) centre support beam is also required to hold the demister.

**4. Special Supports Arrangements:**

Apart from general support arrangements some unit requires special mist eliminator supporting systems and enclosed typical drawing of the same.

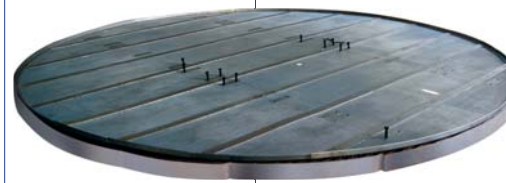
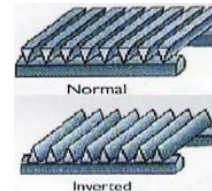
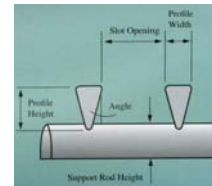
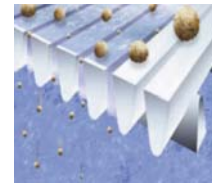
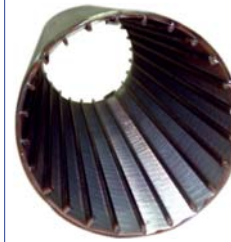
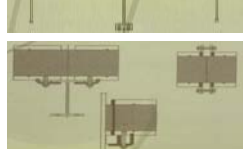
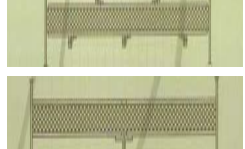
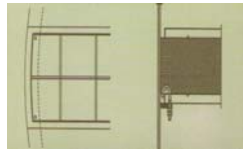
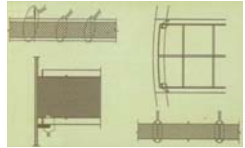
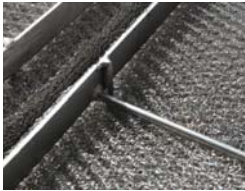

**WEDGE WIRE SPECIFICATIONS**

Number	Width in mm	Height in mm	Angle	Min. slot Opening mm
Q - 30	0.75	1.30	13°	Minimum slot opening @ ±0.05MM
Q - 43	1.10	2.20	13°	
Q - 63	1.52	2.54	13°	
Q - 80	2.00	4.15	08°	
Q - 90	2.26	3.53	13°	
Q - 109	2.82	4.45	13°	
Q - 128	3.00	5.60	13°	
Q - 133	3.35	6.20	13°	
Q - 138	3.50	6.60	13°	
Q - 155	3.90	6.81	13°	



**WEDGE WIRE SCREENS:**

Wedge Wire Screens are manufactured by Triangular wires rigidly welded to rods or flat bars to form a precise opening. These fabricated screens offer narrow opening with high strength which normal wire mesh screens cannot offer.

**CONSTRUCTION:**

Wedge wire screen are offered in normal construction and inverted construction. The total thickness of the construction is calculated as follows.

$$T = \text{Profile Wire Height} + \text{Support Height} - (\text{IMM welding penetration})$$

**Wedge Wire Screens are used as:**

- Liquid / Solids Separation
- Solid Removal From Process Wastewater
- Salt Water Intake Screens & Fiber Removal Screens
- Cylinder for Rotary Screens
- Recovering Solids & Pulp's Thickening Applications
- Heavy Media Recovery & Product Dewatering Screens
- Sieve Bend Screens & In-line Strainers
- Resin Traps & Pressure Screens
- Strainers for Pumps or Compressor Protection
- Support Grid For Uniform Fluid Collection In Filter
- Hub & Header Lateral Screens Systems
- Nozzles for Tube Sheets
- Up flow Clarifiers; Gravity Filters Under Drain Systems

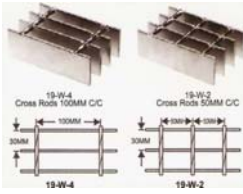

### INDUSTRIAL GRATINGS:

Quality Wire Products Co. W.L.L offers all types of steel gratings and stair treads, tailor made to exact requirement for all industrial products and facilities in all fields such as Petrochemical plants, Power Plants, Steel Plants, Refineries, Cement Factories, Steel Mills, High Rising Towers, etc.

Welded Steel Bar Grating is the most popular of all grating types due to its strength, cost-effective production and easy for installation. World wide in most general industrial plants as well as commercial locations, it has wide applications as walkways, platforms, safety barriers, drainage covers and ventilation grates.

It is also ideal for use as decking since it supports the same loads as compared to solid flooring. Usage of Gratings maximizes the circulation of air, light, heat, water and sound, while it provide a clean environment. Standard panels are available in widths of 2', 3' or 4'. Welded steel bar grating is resistance welded to create a rugged, one-

piece constructed panel. The bearing bars are automatically resistance welded at the contact point with the cross bars and under a combination of high heat and pressure are fused together to form a permanent joint. The cross bars provide a high degree of rigidity, yet retain a smooth flat surface for free and easy walking. Quality Wire Products Co. W.L.L offers a gratings in stainless steel and all other high end alloys like Monel, with different openings of cross bar and bearing bar typically to suit the individual requirement of the customers.

Quality Wire Products Co. W.L.L offers gratings suitable for pressure vessel industry and special process and engineering calculations are done based on the customer requirements and gratings can be designed based on process information.

Grating Available in the following Materials: Mild Steel, Hot Dip Galvanized, Stainless Steel All Grades, Monel and other Special Alloys.

### Standard Specifications for Steel Gratings in Mild Steel and Galvanized

Bar Size D x W (mm)	Bearing Bar Spacing	Cross Bar Spacing	Bar Size D x W (mm)	Bearing Bar Spacing	Cross Bar Spacing
20 x 3	30	100	55 x 4 /5	30	100
25 x 3	30	100	60 x 4 /5	30	100
30 x 3	30	100	20 x 4 /5	30	50
35 x 3	30	100	25 x 4 /5	30	50
20 x 4 /5	30	100	30 x 4 /5	30	50
25 x 4 /5	30	100	35 x 4 /5	30	50
30 x 4 /5	30	100	50 x 4 /5	30	50
35 x 4 /5	30	100	50 x 4 /5	30	50
50 x 4 /5	30	100	55 x 4 /5	30	50
50 x 4 /5	30	100	60 x 4 /5	30	50

### Custom Made Grating

Bar Size D X W (mm)	Bearing Bar Spacing	Cross Bar Spacing
10 to 60 X 2 to 6	30 - 100	25 - 100

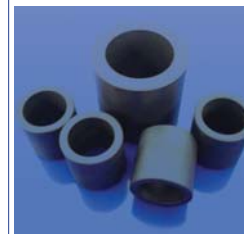

### TOWER PACKINGS AND STRUCTURED PACKINGS:

Quality Wire offer the following packing internals which are used in the refinery and gas processing industry and mass transfer applications.

#### QWP Progressive Metal Packing:

Quality Wire Progressive Metal Packing (QWPMP) is made of metal sheets and give the best performance with relation to low pressure drop and high efficiency. These Packings are made in progressive die tool with complete precision to ensure the best quality. Common Sizes Available is 12; 25; 40; 50 & 70. These random Packings available in various metals such as carbon steel, Stainless Steel all grades and other special alloy steel grades. The below Packings are equivalent to other international brand types.

Type	Piece Density Pcs/M3	Surface Area M2/M3	Void age %	Approx Bulk Weight Kg/M3
QWPMPPI - 15	347500	291.3	95.60	280 to 284 Kg/M3
QWPMPPI - 25	135000	225.8	96.60	222 to 226 Kg/M3
QWPMPPI - 40	50000	150.8	97.70	151 to 155 Kg/M3
QWPMPPI - 50	15000	100	98	164 to 168 Kg/M3
QWPMPPI - 70	4625	690	98.50	138 to 144 Kg/M3

#### QWP Q – PAK Metal Packing:

Q-Pak is once again a progressive die tool products and Q Pak is an excellent improvisation of the traditional pall rings and is considered to be the most efficient ring type packing. With more numbers of internal strips the interactive area increases for gas liquid contact so these type of rings maintains the efficiency of packing when compared to normal pall rings. With the same efficiency it gives lower pressure drop than pall ring. Due to the special design the thickness of the rings are reduced, reducing investment cost while replacing pall rings with the same.

Type	Piece Density Pcs/M3	Surface Area M2/M3	Void age %	Approx Bulk Weight Kg/M3
QWPQ-PAK1 - 30MM	30000	171.9	96.5	260 to 264 Kg/M3
QWPQ-PAK1.5-45MM	9400	118.03	97.04	178 to 282 Kg/M3
QWPQ- PAK2-60MM	3870	84.10	97.4	158 to 164 Kg/M3
QWPQ- PAK3-90MM	1100	57.10	97.7	178 to 184 Kg/M3

#### QWP PALL RINGS:

Traditional Pall Rings are simple rings with no internal strips mostly used as replacement tools. They are available in metal, plastic ad ceramic In most applications these rings are replace by internal strips rings (Q-Pak) due to better performance. These rings are used in the heat transfer applications; absorbers and scrubbing and stripper application.

Type	Piece Density Pcs/M3	Surface Area M2/M3	Void age %	Approx Bulk Weight Kg/M3
QWPQ-Pall Ring 16MM	214000	344.20	93.10	530 to 540 Kg/M3
QWPQ-Pall Ring 25MM	51000	206.70	94.80	322 to 328 Kg/M3
QWPQ-Pall Ring 38MM	14300	130.40	96.08	205 to 210 Kg/M3
QWPQ-Pall Ring 50MM	6500	102.10	95.90	195 to 200 Kg/M3

#### QWP Carbon Raschig Rings:

Raschig Rings are made from Carbon or Graphite used in specific applications to withstand good corrosion and thermal shock resistance. They are resistant to most acids; alkalis and solvents at high temperature and also display good erosion and thermal stock resistance. At the same time they have high crushing strength thus have a long life. They are available in variable sizes such as 10MM,19MM, 50MM & 75MM.



**STRUCTURED PACKING FOR DISTILLATION COLUMNS:**

QWP MAKE STRUCTURED PACKINGS are effectively used for separation application in the gas processing plants: Chemical Processing Industries & in the Oil & Gas industries typically for separation applications.

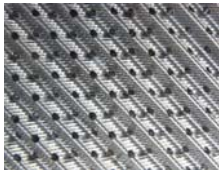

Two Types of structured Packing's are most used common packing and below are the details.

**Metal Structured Packing:-**

- Wire Mesh Gauze Structured Packing
- Sheet metal Structured Packing in Carbon Steel
- Sheet Metal Structured Packing in Stainless Steel
- Sheet Metal Structured Packing in Nickel alloys

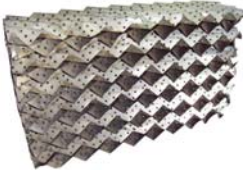

**NON Metallic Extruded Structured Packing:-**

- PVC, PP, PVDF & TEFLON – Non metallic Structured Packing's

**Design & Supply:**

Our in house process engineers design and supply various types of structured Packing's depending upon the requirements along with support beds and other internals according to the needs of the end user. QWP Make Metallic Structured Packing are manufactured in thin

sheets with thickness range from 0.10MM to 0.40MM thin strips are knurled to form a rough surface on single or both the sides and then further perforated for the liquids to drain through the holes and finally corrugated in 45° or 60° or in curved shape according to the process requirements. QWP Make structured Packing's are fabricated from 100MM (4Inch) dia to 8000MM dia (315Inches) dia with each segment thickness from 150MM to 250MM and made in segments suitable to pass through the manhole. Several segments are installed inside the columns with each segment installed exactly at 90° opposite direction inside the columns for the best performance.

**Supports/Gratings:**

QWP Make structured Packing's are installed together with QWP Make support gratings made out of flat bar; expanded metal or perforated sheet or with QWP Make wedge wire screen. Wide open area is created in the supports at the same time supports are reinforced to handle the entire process load including the differential pressure. Our trained staffs help identify the suitable support for different application according to the end user requirements. For best performance of QWP Make structured Packing's, please use the QWP recommended supports.

QWP Make Typical Metallic Structured Packing Type	Surface M2/M3	Voidage %	Factor(F) M/Sec (Kg/M3)	Type of Corrugation
QWP – Type : 1	125M2/M3	98.5 %	1.0 – 3.0	45° or 60° or Curve
QWP – Type : 2	250M2/M3	97.5 %	0.8 – 2.5	45° or 60° or Curve
QWP – Type : 3	350M2/M3	96.5 %	1.0 – 2.5	45° or 60° or Curve
QWP – Type : 4	500M2/M3	97 %	2.0 – 2.5	45° or 60° or Curve
QWP – Type : 5	500M2/M3	95 %	0.6 to 1.8	45° or 60° or Curve
QWP – Type : 6	750M2/M3	95.7 %	1.5 – 2.0	45° or 60° or Curve



QWP STRAINERS

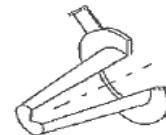

TYPICAL STRAINER

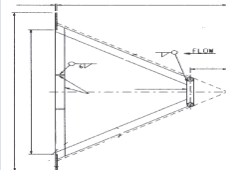

QWP TYPE 1.1 to 1.9

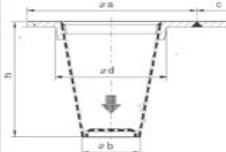

QWP TYPE : 2

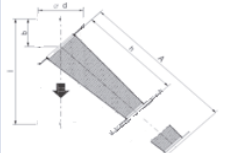

QWP TYPE : t3



QWP STRAINERS

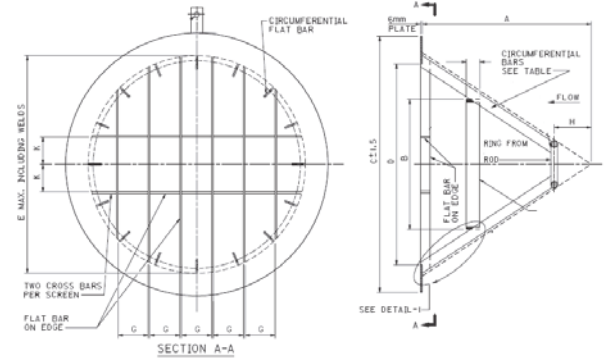

Model	PIPE SIZE in.	A mm	B mm	C mm	D mm	E mm	H mm	ALLOWABLE PRESSURE DIFFERENCE OVER SCREEN KPa
QWP TYPE 1.1	16	380	-	505	320	360	100	193
QWP TYPE 1.2	20	500	280	600	440	470	120	290
QWP TYPE 1.3	24	640	320	710	540	570	160	159
QWP TYPE 1.4	30	840	440	875	680	720	200	179
QWP TYPE 1.5	32	880	460	930	740	770	200	221
QWP TYPE 1.6	34	940	480	980	780	820	200	179
QWP TYPE 1.7	36	1000	500	1040	840	870	200	193
QWP TYPE 1.8	40	1160	560	1155	940	970	200	165
QWP TYPE 1.9	42	1240	580	1210	1000	1030	200	145

Strainers are used in steam, water, oil or gas where protection from foreign matter in a pipeline is required. Perforated Sheets are rolled and formed into a conical shape with additional layers of wire mesh spot welded to the conical strainer. These strainers have the desired open area and are fabricated to withstand the required pressure drop. Additional reinforcements can be made on the strainers if required.

Model	PIPE SIZE in.	A mm	B mm	C mm	D mm	E mm	H mm	ALLOWABLE PRESSURE DIFFERENCE OVER SCREEN KPa
QWP TYPE 2 & 3	Please specify the above data and we shall fabricate the strainer and supply the same							

## COALESCERS ANTI FOAMING/LIQUID LIQUID SEPARATOR

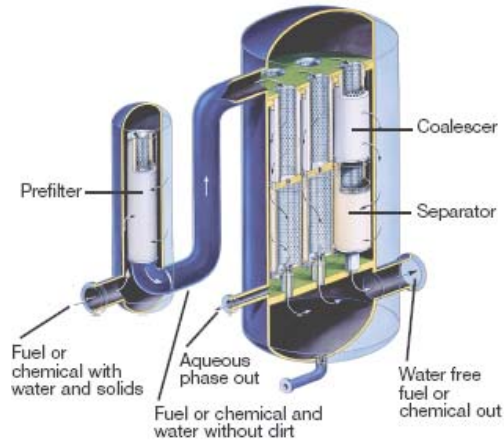

Phases up liquid-liquid coalescers can also be used to separate hydrocarbons from water phases such as oil removal from produced water. They have been also used in pyrolysis gasoline (benzene) removal from quench water in ethylene plants. We make both Plate and Knitted Mesh coalescers in stainless steel and nickel and copper alloy materials. Depending upon the requirement they can be used solely or in combination to separate a wide range mechanically induced emulsions. Hydrophobic and hydrophilic materials are available to achieve desired separation results. All separator packs are built to customer specifications or performance requirements and designed for high efficiency and long reliable service.

Advantages are cost savings due to smaller vessel size, Increase in capacity for existing vessels, Savings due to recovery of solvents, Better product quality, Reduced tank inventory and Compliance with regulatory laws

We make both Plate and Knitted Mesh coalescers in stainless steel and nickel and copper alloy materials. Depending upon the requirement they can be used solely or in combination to separate a wide range mechanically induced emulsions. Hydrophobic and hydrophilic materials are available to achieve desired separation results. All separator packs are built to customer specifications or performance requirements and designed for high efficiency and long reliable service.

Advantages are cost savings due to smaller vessel size, Increase in capacity for existing vessels, Savings due to recovery of solvents, Better product quality, Reduced tank inventory and Compliance with regulatory law.

A Coalescer is a technological device performing coalescence. They are primarily used to separate emulsions in to their components via various processes; operating in reverse to an emulsifier.

In the area of compressed air purification, coalescing filters are used to separate liquid water and oil from compressed air using a coalescing effect. These filters additionally remove particles.

Liquid-Gas coalescers in the Oil and Gas, Petrochemical and Oil Refining industries, Liquid-Gas coalescers are widely used to remove water and hydrocarbon liquids to <0.011 ppm (plus particulate matter to <0.3 um in size) from natural gas to ensure natural gas quality and protect downstream equipment such as compressors, gas turbines, amine or glycol absorbers, molecular sieves, PSA's, metering stations, mercury guard beds, gas fired heaters or furnaces, heat exchangers or gas-gas purification membranes.

Liquid-liquid coalescers are widely used in oil refining industry to remove contaminants like amine or caustic from intermediate products in oil refineries and also for dewatering final products like kerosene (jet fuel), LPG, gasoline and diesel to <15 ppm free water in the hydrocarbon phase.



TYPICAL QWP SYTLE COALASCERS	Density	Wire dia	Surface	Free Volume	Remarks
	[kg/m <sup>3</sup> ]	mm	m <sup>2</sup> /m <sup>3</sup>	%	
<b>Metallic types</b>					
QWP -Coalascer -Type 5	144	0.25 to 0.28	344 to 386	97.58	
QWP -Coalascer -Type 7	193	0.25 to 0.28	344 to 386	97.58	Aqueous phase is dispersed
QWP -Coalascer -Type 8A	232	0.25 to 0.28	414 to 464	97.1	
<b>Non-metallic types</b>					
QWP-Type : 1 Coalascer (Polypropylene)	72	0.39 to 0.40	760 to 790	92,3	Organic phase is dispersed
QWP-Type : 2 Coalascer (Polypropylene)	102	0.215 to 0.225	1990 to 2040	89,0	
QWP-Type : 5 Coalascer (Polypropylene)	144	0.39 to 0.40	1590 to 1620	94,0	
QWP-Type : 5 Coalascer (DACRON)	145	0.265 to 0.275	360	91,9	

Metal & Plastic Co Knit	Density [kg/m <sup>3</sup> ]	Surface m <sup>2</sup> /m <sup>3</sup>	Free Volume %	Remarks
QWP Type -8- Coalascer SS/Glass fibre	200	5000	94,8	High efficiency
QWP Type -8A- Coalascer SS/Glass fibre	240	6000	93,7	
QWP-Type-7-Coalascer-SS/Polypropylene	192	676	94,0	High flexibility
QWP Type 8A Coalascer-SS/Polypropylene	240	845	92,5	
QWP Type -8- Coalascer GSF/PP	200	8000	93,1	High efficiency

Corrugated Sheet Metal Coalascers	Density [kg/m <sup>3</sup> ]	Sheet Thick	Surface	Angle	Remarks
QWP – Type : 1 Structured Packing	200	0.20	250M2/M3	45 Deg or 60 Degree	High performance
QWP – Type : 2 Structured Packing	50 to 100	0.10 to 0.15	125M2/M3	45 Deg or 60 Degree	For light liquid and for high foams

**QWPC PERFORATED METAL SHEETS:**

**Guidelines for Minimum Hole Size/Minimum Bar Width**

The rule of thumb for perforating is that the hole diameter should not be less than the thickness of the material. The closer to a 1-to-1 ratio, the higher the probability of tool failure and the greater the precautions necessary to avoid it. Modifications can be made in certain instances at additional costs. For stainless steel and similar higher strength materials, it is preferable to specify at least three thickness gauges thinner than hole diameter.

The same general rule applies to bar width. The bar width should be greater than the material thickness because of the increased number of punches and, therefore, increased perforation tonnage. The bar width can be adjusted at increased costs.

0.27\" Dia. 0.50\" Str. Ctrs. 23% O/A	0.33\" Dia. 0.50\" Str. Ctrs. 28% O/A	1/16\" Dia. 1/8\" Str. Ctrs. 74 Holes PSI 22.5% O/A	1/16\" Dia. 1/8\" Str. Ctrs. 74 Holes PSI 22.5% O/A	1/16\" Dia. 1/8\" Str. Ctrs. 74 Holes PSI 22.5% O/A	1/16\" Dia. 7/64\" Str. Ctrs. 98 Holes PSI 30% O/A
1/16\" Dia. 1/8\" Str. Ctrs. 74 Holes PSI 22.5% O/A	1/16\" Dia. 1/8\" Str. Ctrs. 74 Holes PSI 22.5% O/A	1/16\" Dia. 1/8\" Str. Ctrs. 74 Holes PSI 22.5% O/A	1/16\" Dia. 1/8\" Str. Ctrs. 74 Holes PSI 22.5% O/A	1/16\" Dia. 7/64\" Str. Ctrs. 98 Holes PSI 30% O/A	1/16\" Dia. 1/8\" Str. Ctrs. 74 Holes PSI 22.5% O/A
1/16\" Dia. 1/8\" Str. Ctrs. 74 Holes PSI 22.5% O/A	1/16\" Dia. 1/8\" Str. Ctrs. 74 Holes PSI 22.5% O/A	1/16\" Dia. 1/8\" Str. Ctrs. 74 Holes PSI 22.5% O/A	1/16\" Dia. 7/64\" Str. Ctrs. 98 Holes PSI 30% O/A	1/16\" Dia. 1/8\" Str. Ctrs. 74 Holes PSI 22.5% O/A	1/16\" Dia. 1/8\" Str. Ctrs. 74 Holes PSI 22.5% O/A
1/16\" Dia. 1/8\" Str. Ctrs. 74 Holes PSI 22.5% O/A	1/16\" Dia. 1/8\" Str. Ctrs. 74 Holes PSI 22.5% O/A	1/16\" Dia. 7/64\" Str. Ctrs. 98 Holes PSI 30% O/A	1/16\" Dia. 1/8\" Str. Ctrs. 74 Holes PSI 22.5% O/A	1/16\" Dia. 1/8\" Str. Ctrs. 74 Holes PSI 22.5% O/A	1/16\" Dia. 1/8\" Str. Ctrs. 74 Holes PSI 22.5% O/A
1/16\" Dia. 1/8\" Str. Ctrs. 74 Holes PSI 22.5% O/A	1/16\" Dia. 7/64\" Str. Ctrs. 98 Holes PSI 30% O/A	1/16\" Dia. 1/8\" Str. Ctrs. 74 Holes PSI 22.5% O/A	1/4\" Dia. 1/2\" Str. Ctrs. 20% O/A	5/16\" Dia. 7/16\" Str. Ctrs. 46% O/A	5/16\" Dia. 15/32\" Str. Ctrs. 40% O/A
3/8\" Dia. 1/2\" Str. Ctrs. 5 Holes PSI 52% O/A	3/8\" Dia. 9/16\" Str. Ctrs. 4 Holes PSI 40% O/A	7/16\" Dia. 5/8\" Str. Ctrs. 45% O/A	1/12\" Dia. 11/16\" Str. Ctrs. 25 Holes PSI 48% O/A	1/2\" Dia. 3/4\" Str. Ctrs. 2 Holes PSI 40% O/A	9/16\" Dia. 3/4\" Str. Ctrs. 205 Holes PSI 51% O/A
5/8\" Dia. 7/8\" Str. Ctrs. 1.5 Holes PSI 46% O/A	5/8\" Dia. 13/16\" Str. Ctrs. 54% O/A	5/8\" Dia. 1\" Str. Ctrs. 35% O/A	3/4\" Dia. 1\" Str. Ctrs. 1.1 Holes PSI 51% O/A	7/8\" Dia. 1/4\" Str. Ctrs. 44% O/A	1\" Dia. 1-1/4\" Str. Ctrs. 0.74 Holes PSI 57% O/A
<b>AIRLINE</b> 1/4\" x 1-1/2\" Rectangular Slots 68% O/A Straight rows parallel to width 3/32\" bar every third bar 3/16\" lengthwise. LWS Parallel to width of sheet	<b>3/4\" SQUARE</b> 1\" Straight Row Centers 57% O/A	<b>LATTICE</b> 1/2\" Square, 11/16\" Str. Rows 53% O/A			
<b>3/8\" SQUARES</b> 1/2\" Str. Row Centers 1/8\" Bar 56% O/A	<b>200 SQUARE</b> 1/2\" Straight Rows 16% O/A	<b>HANOVER SQUARE</b> 200 SQ. 1/4\" Str. Rows 64% O/A	<b>WINDSOR</b> 45% O/A	<b>GRECIAN</b> 35% O/A	
<b>OCTAGON CANE</b> 9/32\" Octagons, 7/64\" Round 36% O/A	<b>FULL CLOVERLEAF</b> 1/2\" Staggered Clovers 51% O/A	<b>1/4\" HONEYCOMB</b> 1/4\" Hex. 9/32\" Staggered 79% O/A	<b>HEXAGON</b> 1/2\" Hex. 9/16\" Centers 1/16\" Bar 80% O/A	<b>MOIRE</b> 1/8\" x 3/4\" Round End Slot 1/8\" BARS 41% O/A LWS Parallel to length of sheets	

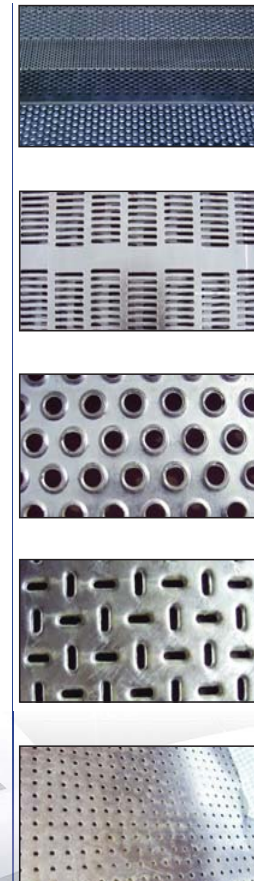

**HOW TO ORDER/SPECIFY:**

**CONSIDER:**

1. Application or use of product
2. Physical requirements (open area, strength etc.)

**PLEASE SPECIFY:**

1. Quality perforated metal.
2. Quantity: number of cut pieces or full sheets.
3. Material: type of material desired, carbon steel, stainless steel, aluminum etc.
4. Thickness: for steel or stainless steel specify gauge or thickness in inches. All other metals specify in inches only.
5. Width: over all width "Mill Tolerances will be supply"
6. Length: overall length, unless otherwise indicated.
7. Perforation size, shape and arrangement: refer to perforated patterns and tooling lists staggered arrangement (60° pattern) is standard (for screens – normally staggered in direction of flow of material). Straight line or other pattern must be specified; slotted perforations must be noted as parallel to length or width.
8. Hole Bar Centers: (metal between perforations) center to center measures width of bar at point where perforations are closest.
9. Blank Margins: dimensions of blank margins, parallel width and length (+ or – tolerance). Costs increases when blank margins are required.
10. Flatness: requirements for flatness.
11. End pattern: "finished or unfinished end pattern" if available.
12. Special requirements: special shearing, leveling, finish heat treating if any.





VARIOUS SIZES & TYPES OF PERFORATED SHEETS				
ROUND	PITCH	ALL GRADES AND OTHER NICKEL ALLOYS	Thickness	OPEN AREA
<b>BLACK &amp; GALVANIZED STEEL, SS ALL GRADES AND OTHER NICKEL ALLOYS</b>				
0.7	1.27	Strt & Stgrd	0.5	23.00%
1.2	1.8	Strt & Stgrd	0.5 TO 1.0	36.00%
1.2	2.25	Strt & Stgrd	0.5 TO 1.1	24.00%
1.6	2.8	Strt & Stgrd	0.5 TO 1.2	33.00%
1.6	2.4	Strt & Stgrd	0.5 to 1.2	41.00%
1.6	2.8	Strt & Stgrd	0.5 TO 1.2	30.00%
1.6	3.2	Strt & Stgrd	0.5 TO 1.2	23.00%
2	2.5	Strt & Stgrd	0.5 TO 1.5	51.00%
2	2.8	Strt & Stgrd	0.5 TO 1.5	46.00%
2.5	3	Strt & Stgrd	0.5 TO 1.5	36.00%
2.5	3	Strt & Stgrd	0.5 TO 2.0	51.00%
2.5	4	Strt & Stgrd	0.5 TO 2.0	33.00%
2.5	5	Strt & Stgrd	0.5 TO 2.0	23.00%
2.5	6	Strt & Stgrd	0.5 TO 2.0	12.70%
3	4	Strt & Stgrd	0.5 TO 3.0	51.00%
3.2	5	Strt & Stgrd	0.5 TO 3.0	40.00%
3.2	5.5	Strt & Stgrd	0.5 TO 3.0	30.00%
3.2	6	Strt & Stgrd	0.5 TO 3.0	23.00%
3.6	5	Strt & Stgrd	0.5 TO 3.0	51.00%
4	5	Strt & Stgrd	0.5 TO 3.0	63.00%
5	6	Strt & Stgrd	0.5 TO 4.0	50.00%
5	8	Strt & Stgrd	0.5 TO 4.0	32.00%
6	8	Strt & Stgrd	0.5 TO 6.0	58.00%
6	10	Strt & Stgrd	0.5 TO 6.0	40.00%
6	12	Strt & Stgrd	0.5 TO 6.0	22.70%
6	12	Strt & Stgrd	0.5 TO 6.0	22.70%
8	12	Strt & Stgrd	0.5 TO 8.0	46.00%
8	12	Strt & Stgrd	0.5 TO 8.0	40.00%
10	12	Strt & Stgrd	0.5 TO 8.0	52.00%
10	14	Strt & Stgrd	0.5 TO 8.0	40.00%
12	8	Strt & Stgrd	0.5 TO 8.0	0.00%
20	25	Strt & Stgrd	0.5 TO 12.0	48.00%
20	25	Strt & Stgrd	0.5 TO 12.0	51.00%
25	35	Strt & Stgrd	0.5 TO 12.0	58.00%
5.0 Square	12.5	Strt & Stgrd	0.5 TO 5.0	16.00%
5.0 x 16 Square Slots			0.5 TO 5.0	74.00%
Hanover 2Square x 6 Str			0.5 TO 5.0	64.00%
6.0 Square x 8.0 Str			0.5 TO 6.0	64.00%
10.0 Square 12.5 Str			0.5 TO 10.0	56.00%
Lattice 12.5 sq. 18.0MM			0.5 TO 12.5	53.00%
Full cover		PLS CALL		51.00%
Grecian		PLS CALL		35.00%
Honeycomb (6.0hex)		PLS CALL		79.00%
Square Link		PLS CALL		40.00%
Octagon Cane		0.7		36.00%
Windsor		1		45.00%
6 Perf Panel (intended)		1		4.90%
Moire 3.0 x 10 Slot		0.8		41.00%
Airline 6 x 35 Slot		1.2 & 1.6		68.05%
12Hex X 15 Stg		1.6		80.00%
Perf-Grip Flooring		1.6 TO 2.5	Inquire	
Tread-Grip Flooring		1.6 TO 3.0	4.00%	
Safety Tread flooring		1.6 TO 3.0	7.00%	
<b>POLYPROPYLENE PLASTIC</b>				
3.0 Plastipert	5	Strt & Stgrd	1.6	40.00%
5.0 Plastipert	8	Strt & Stgrd	3	32.00%
<b>BLACK &amp; GALVANIZED STEEL-SS ALL GRADES AND OTHER NICKEL ALLOYS</b>				
0.85	1.2	Strt & Stgrd	0.8	28.00%
1.6	2.5	Strt & Stgrd	0.8 TO 1.6	41.00%
1.6	3	Strt & Stgrd	0.8 TO 1.6	30.00%
1.6	3.5	Strt & Stgrd	0.8 TO 1.6	23.00%
1.6	6.5	Strt & Stgrd	0.8 TO 1.6	6.00%
2.5	4	Strt & Stgrd	0.8 TO 2.0	33.00%
2.5	4	Strt & Stgrd	0.8 TO 2.0	23.00%
3	4	Strt & Stgrd	0.8 TO 3.0	51.00%
3	4	Strt & Stgrd	0.8 TO 3.0	40.00%

ROUND	CENTERS	GAUGE	OPEN AREA
<b>ALUMINIUM</b>			
4	5	Strt & Stgrd	0.5 To 3.0
4	6	Strt & Stgrd	0.5 To 3.0
5	6	Strt & Stgrd	0.5 To 5.0
5	8	Strt & Stgrd	0.5 To 5.0
5	8	Strt & Stgrd	0.5 To 5.0
6	8	Strt & Stgrd	0.5 To 6.0
6	10	Strt & Stgrd	0.5 To 6.0
8	8	Strt & Stgrd	0.5 To 8.0
10	15	Strt & Stgrd	0.5 To 10.0
12	18	Strt & Stgrd	0.5 To 12.0
6Sq	10	Strt & Stgrd	0.5 To 6.0
8 Sq.	12	Strt & Stgrd	0.5 To 8.0
20	25	Strt & Stgrd	0.5 To 20.0
honeycomb (6.0hex)			0.5 To 6.0
airline			0.5 To 3.0
windsor			0.5 To 3.0
tread-Grip Flooring			0.5 To 3.0
safety Tread flooring			0.5 To 3.0
*available as 5052H-32			
<b>GALVANIZED STEEL &amp; STAINLESS STEEL</b>			
1	2	Strt & Stgrd	0.5 To 1.0
1.5	2	Strt & Stgrd	0.5 To 1.5
1.5	2.5	Strt & Stgrd	0.5 To 1.5
1.6	2.5	Strt & Stgrd	0.5 To 1.6
2	3	Strt & Stgrd	0.5 To 2.0
2.4	4.8	Strt & Stgrd	0.5 To 2.0
2.5	5	Strt & Stgrd	0.5 To 2.0
3	5	Strt & Stgrd	0.5 To 3.0
3	6	Strt & Stgrd	0.5 To 3.0
3	8	Strt & Stgrd	0.5 To 3.0
4	6	Strt & Stgrd	0.5 To 4.0
4	8	Strt & Stgrd	0.5 To 4.0
4	10	Strt & Stgrd	0.5 To 4.0
5	8	Strt & Stgrd	0.5 To 4.0
5	10	Strt & Stgrd	0.5 To 4.0
6	6	Strt & Stgrd	0.5 To 6.0
6	8	Strt & Stgrd	0.5 To 6.0
6	9	Strt & Stgrd	0.5 To 6.0
6	12	Strt & Stgrd	0.5 To 6.0
8	12	Strt & Stgrd	0.5 To 8.0
hanover 5 Square			0.7
<b>MONEL 400</b>			
1 TO 4	2 TO 10	Strt & Stgrd	0.5 To 2.0
4 TO 16	6 TO 50	Strt & Stgrd	1.5 To 8
16 TO 32	25 TO 50	Strt & Stgrd	0.5 To 8.0
SPECIAL CUSTOM MADE TOOLS	0.5 TO 8.0	Variable	
<b>OTHER NICKEL ALLOYS (SPECIAL)</b>			
1 TO 2	2 TO 10	Strt & Stgrd	0.5 To 1.0
2 TO 3	2 TO 25	Strt & Stgrd	0.5 To 2.0
3 TO 4	3 TO 25	Strt & Stgrd	0.5 To 3.0
4 TO 5	4 TO 25	Strt & Stgrd	0.5 To 4.0
5 TO 6	5 TO 25	Strt & Stgrd	0.5 To 5.0
6 TO 8.0	6 TO 25	Strt & Stgrd	0.5 To 6.0
8 TO 10	8 TO 50	Strt & Stgrd	0.5 To 8.0
10 TO 12	10 TO 50	Strt & Stgrd	0.5 To 10.0
12 TO 20	12 TO 50	Strt & Stgrd	0.5 To 10.0
20 TO 50	25 TO 60	Strt & Stgrd	0.5 To 12.0
SPECIAL CUSTOM MADE TOOLS			0.5 To 12.0
<b>BRASS</b>			
0.8	1.5	Strt & Stgrd	0.5
<b>TIN PLATE</b>			
8	10	Strt & Stgrd	0.7
<b>INCOLLOY</b>			
2	3	Strt & Stgrd	0.5

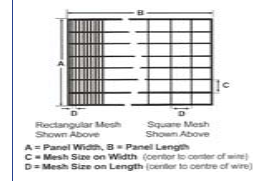

**WELDED WIRE MESH:**

Material: Mild Steel Black Finish Hot Dip Galvanized Steel & Other Special Alloys.

Weld mesh is one of the most versatile of all Wire Cloth products. Weld mesh is a welded steel wire mesh manufactured from steel wire, electrically welded at all intersections. Because it is welded, it can be cut or bent to the shapes required without the wires falling apart and forms its own selvage when cut flush. Weld mesh is available in panels in a variety of wire diameters and meshes up to 8". The physical properties of the wires are rigidly controlled to produce a welded mesh which has maximum weld strength. Please call us for product assistance.

**APPLICATIONS:**

Security Guards • Pallets/Bins • Screens/Grilles • Suspended Ceilings • Machine Guards • Fencing/Gates • Lockers • Balustrading • Catwalk Guards • Safety Barriers • Racking/Shelving • Containers • Stairway Guards • Screened Partitions

**OUR ADVANTAGES:**

High Strength • Flush edge finish • Solid construction • Easy handling • Easy cutting • Versatile • All intersections welded • Wires hold together • Cutouts made easily

Aperture Size mm	Wire Dia. mm	Available Type
200 x 200	3 to 8	In Panels
150 x 150	2 to 8	In Panels
100 x 100	2 to 8	In Panels / Rolls
75 x 100	2 to 8	In Panels / Rolls
100 x 75	2 to 6	In Panels / Rolls
50 x 50	1.5 to 6	In Panels / Rolls
50 x 75	1.5 to 6	In Panels / Rolls
50 x 25	1.5 to 6	In Panels / Rolls
25 x 25	0.9 to 6	In Panels / Rolls
25 x 50	0.9 to 6	In Panels / Rolls
25 x 75	0.9 to 6	In Panels / Rolls
20 x 20	0.9 to 4	In Panels / Rolls
15 x 15	0.9 to 3	In Panels / Rolls
12.5 x 12.5	0.9 to 2	In Panels / Rolls

Standard Panels or Cut-to-Sizes are available.

**HOW TO ORDER/ SPECIFY:**

Welded wire cloth should be specified as "Trimmed" or "Untrimmed" and stub options required. Please see the following examples for assistance in specifying or ordering welded wire cloth.

Note: Please specify if clear opening is required instead of mesh. For cut to sizes, there may be stubs on one or more sides. Hot dip galvanizing can increase the wire diameter thickness by 3-4 thousands of an inch.

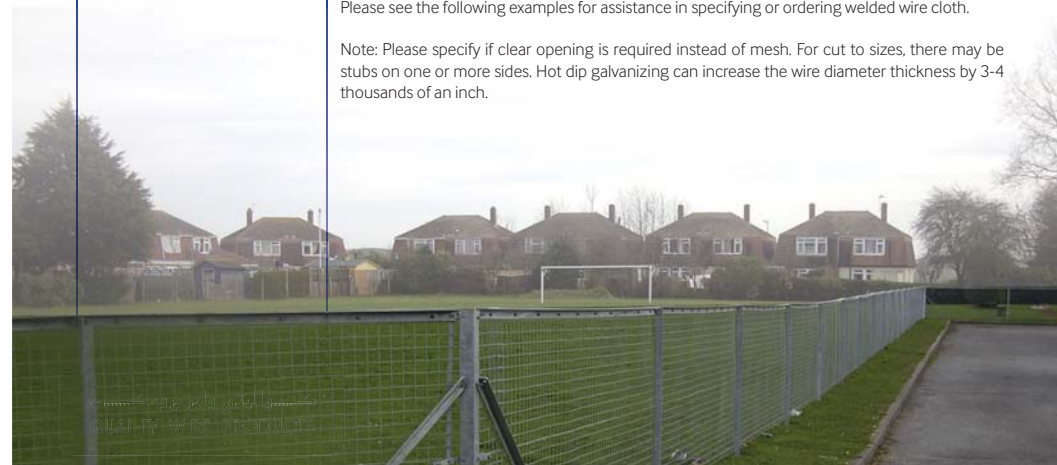

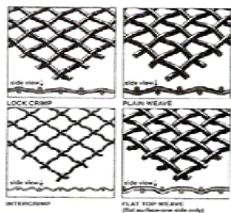

### CRIMPS & WEAVES

**Lock Crimp** – Provides accurate screen openings for life of the screen. Used when plain weave will not hold accurate openings.

**Plain Weave** – Opening are square and wire sizes are the same in both directions. Each warp wire passes alternately over and under shute wires at right angles both directions. Standard type of weave used for wire cloth. (Sometimes called double crimp).

**Intercrimp** – Used in larger openings with light wire to provide greater stability, tightness of weave and maximum rigidity.

**Flat Top Weave** – Flat surface improves flow of materials over screen panels by reducing friction. Provides more wearing surface than other weaves. Locking weaves assures accurate openings to provide uniform grating and screening efficiency.

**Sta Clear aka Tri lock Weave** – Ideal for working with sticky or wet material that normally plugs square or oblong opening screens. Tri Lock Weave holds wire securely in place yet permits wires to vibrate slightly to keep openings free and at peak efficiency.

Other weaves and crimps are available – Please consult your customer service specialist for details.

### WIRE CLOTH

#### HOW TO ORDER/SPECIFY:

Inquiry or order will process more quickly if you have the following information available when you call.

#### CONSIDER:

1. Application or use of product (including environment).
2. Physical requirements
  - Opening size
  - Percent of open area

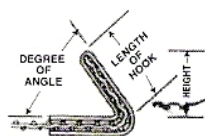

#### PLEASE SPECIFY:

1. Quantity (number of pieces, rolls or screens required.)
2. Material Type (e.g., stainless steel 304, Carbon steel, etc.)
3. Width and Length
4. Wire Diameter (in decimals thousands of an inch)
5. Wire opening (provide mesh count for lineal inch or width of opening -clear opening between wires-in inches. Also state if square, rectangular or other type of opening shape.)
6. Construction (specify – welded or woven and type of weave.)
7. Special fabrication (submit drawing for special requirements such as notching, bolt holes, special shape, bending, forming, calendaring, etc.)
8. Alternates (delivery maybe improved if an acceptable substitute is permitted.)
9. **Screens** : for grading or sizing applications - additional required information:
  - Size** : if ordering more than one screen specification, please list it separately.
  - Width** : state outside hook flange (OHF) or inside hook flange (IHF) measurement of hooked strip or edge style. OHF is preferred. Normal tolerance is +0"-1/2".
  - Length** : include over lap, if required.
  - Arching** : specify or furnish drawing, normal arching ranges 1" – 2" (heavy screens maybe difficult to install if not arched).
  - Lapping** : 1" lap is standard with notched corners, specify if different indicate lap. If required, giving outside or inside diameter and if welded, type of welded seam.

#### Strip & Hooked Edge Treatment:

- A. Specify hooked edge & strip style desire; refer to hook edge diagrams. Hooks are furnished galvanized unless otherwise specified.
- B. State length of hook strip if not the same as screen length and specified any require notching.
- C. Standard degree of hook bend 135° outside/45°inside.
- D. Hook height is measured from top of hook to inside of bend.

### HOOKS STRIPS AND EDGE STYLES

All the based on manufacturer's recomentations. Although it may be possible to put a particular hook style on a wire diameter outside of this recommended ranges, it will generally result in damage to the screen or the machine.

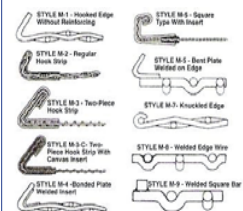

#### HOW TO INSTALL:

1. Vibrator screens need time to seat into place. Install new screen into partial tension without a load and allow vibrating for a brief period of time to seat properly then tightening fully to proper tension. Loose installation will cause premature breakage.
2. Bucker up or crown bar rubber strip should be check every time you change screens- Remember – the rubberweares from the bottom of the rails and wear is not always visible.
3. Check the size of pieces being installed. Also make sure screens have hook strips parallel. Tension uniformly to maintain screen in parallel.

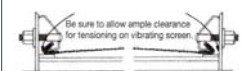

### WIRE CLOTH :

#### VIBRATING SCREENS:

- Square
- Slotted
- Woven
- Stainless Steel
- Plain Steel
- Formed / Plain Edge



Screens for sizing and straining can be furnished by Quality Wire Products with any style of edge preparation or hook strip ready for installation into any type of equipment. Often the edges of the screens woven of heavier than .250" are fabricated to hook into the vibrating frame, similar to Styles M-1 and M-4. However, most screens made of .250" and lighter wire have a hook strip supporting the edges similar to M-2, M-3 or M-5. Edge treatment, whether simply bent hooks or hook strips, should be specified when screens is ordered. Absolutely square hook strips enable screens to be kept under greater, more uniform tension. This protects them against distortion and excessive vibration which causes metal fatigue and breakage.

*Some shaker screens require a special fabrication to meet all OEM specifications.*

#### WIRE CLOTH QUICK REFERENCE GUIDE

Hook/Edge Type	Recommended Wire Range
M-1, M-4, M-6, M-9	.312" dia. and heavier
M-2, M-5	.063 dia to 250" dia
M-3 or M3C	.054 dia and lighter
M-7	.192 dia and heavier
M-8	.148 dia and heavier



#### INSECT SCREEN - PRODUCT DETAILS

Mesh	Wire Dia.	Width	#/SF	Type of Metal
18 x 14	.011	36", 48"	.13	Aluminum
18 x 16	.011	36", 48"	.05	Aluminum
18 x 14	.009	36", 48"	.09	SS -304
18 x 14	.011	36", 48"	.13	SS -304
18 x 14	.009	36", 48"	.09	Epoxy Coated

*For other requirements than shown here, Please contact us. We have Rolls or Cut-To- Length.*

# WIRE MESH - TYPES / SIZE

# WIRE MESH - TYPES / SIZE

Meshes per Linear Inch	Diameter of Wire mm	Width of Opening mm	Open Area Percent	Weight Kgs. per Sq.Mtr (Steel)	Meshes per Linear Inch	Diameter of Wire mm	Width of Opening mm	Open Area Percent	Weight Kgs. per Sq.Mtr (Steel)					
Center To Center	1"	25.4	25.4	39.2	1.63	3.00	76.2	76.2	39.2					
	Center To Center	3/4"	19.0	19.0	30.0	1.25	3.50	89.1	89.1	30.0				
		Center To Center	5/8"	15.9	15.9	23.7	1.00	4.00	101.6	101.6	23.7			
			Center To Center	2 Mesh	12.7	12.7	18.8	0.79	4.50	114.3	114.3	18.8		
				2 1/4	2 1/4	10.2	10.2	15.5	0.63	6.00	152.4	152.4	15.5	
					2 1/2	2 1/2	9.1	9.1	13.7	0.57	7.00	177.8	177.8	13.7
						8.00	8.00	203.2	203.2	100.0	0.16	203.2	203.2	100.0



Meshes per Linear Inch	Diameter of Wire mm	Width of Opening mm	Open Area Percent	Weight Kgs. per Sq.Mtr (Steel)	Meshes per Linear Inch	Diameter of Wire mm	Width of Opening mm	Open Area Percent	Weight Kgs. per Sq.Mtr (Steel)								
8"	8"	203.2	203.2	100.0	0.16	203.2	203.2	100.0	0.16								
	9"	9"	228.6	228.6	100.0	0.15	228.6	228.6	100.0	0.15							
		10"	10"	254.0	254.0	100.0	0.14	254.0	254.0	100.0	0.14						
			12"	12"	304.8	304.8	100.0	0.12	304.8	304.8	100.0	0.12					
				14"	14"	354.4	354.4	100.0	0.11	354.4	354.4	100.0	0.11				
					16"	16"	406.4	406.4	100.0	0.10	406.4	406.4	100.0	0.10			
						18"	18"	457.2	457.2	100.0	0.09	457.2	457.2	100.0	0.09		
							20"	20"	508.0	508.0	100.0	0.08	508.0	508.0	100.0	0.08	
								24"	24"	609.6	609.6	100.0	0.07	609.6	609.6	100.0	0.07

## HEXAGONAL MESH PIPE WINDING

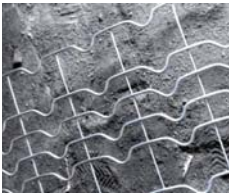

### QWP HEXAGONAL STEEL PIPE WINDING MESH:

Quality Wire Products Co W.L.L is the single largest source in the Middle East for manufacturing and supply of hexagonal wire mesh suitable for Steel Pipe Winding applications. The hexagonal wire mesh fabric are manufactured by twisting wires to form a mesh with a series of hexagonal opening refer to the image below on the right side with one of the edges of the fabric shall be constructed to include a selvedge wire.

Hexagonal Pipe winding mesh is used as reinforcement for steel Pipe which will be coated with concrete and then submersed in water or earth. The wire mesh acts as a holding and a reinforcement agent during the process of concrete coating thus gives additional strength to the concrete coated pipe. The wire mesh helps in holding the concrete intact even after drying preventing the steel pipe from corrosion by not exposing the steel pipe to water or moisture for many years after installation. This helps in the longer life of the pipe laid to transfer water/oil as per end user requirements. With Precise mesh opening and heavy coating we shall produce the excellent quality wire mesh suitable for pipe coating applications.

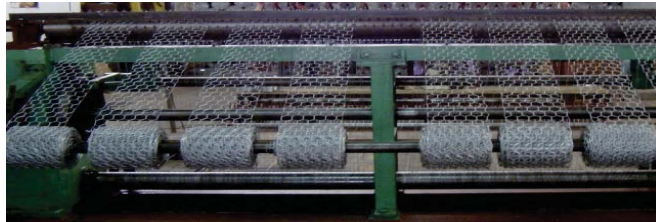

Type	Nominal Aperture	Main Wire Dia.	Line Wire Dia.	Line wire placing	Material	Width	Rolls or panels
QWP PM 1	1½" (38 mm)	0.054" (1.4mm)	0	0	Heavy Coated hot dip galvanized wire with galvanized coating above	190 mm	Individual rolls of length from 100m to 350m as per customer requirement
QWP M 2	1½" (38 mm)	0.054" (1.4mm)	0.048" (1.22mm)	4 ½"		190 mm	
QWP PM 3	1½" (38 mm)	0.054" (1.4mm)	0.048" (1.22mm)	3", 6"		190 mm	
QWP PM 4	1½" (38 mm)	0.054" (1.4mm)	0.048" (1.22mm)	1 ½", 3", 4 ½", 6"		190 mm	
QWP PM 5	1½" (38 mm)	0.054" (1.4mm)	0.048" (1.22mm)	3", 6", 9", 12"		362 mm	



### NOTICE

While every effort has been made to ensure the accuracy of the information within this publication, the use of the information is at the readers risk and no warranty is implied or expressed by Quality Wire Company W.L.L with respect to the use of information contained herein.

The information in this publication is subject to change or modification without notice.



[www.qualitywire.com.bh](http://www.qualitywire.com.bh)

#### **Head Office / Factory**

Bldg. No. 86, Road 19, Block 115, Salman Industrial City, Hidd,  
Kingdom of Bahrain, P.O. Box 33450  
Tel. : +973 17 874000 / 456343, Fax : +973 17 874111 / 456312  
[quality@bataico.com.bh](mailto:quality@bataico.com.bh) / [sales.bahrain@qualitywire.com.bh](mailto:sales.bahrain@qualitywire.com.bh)

#### **Warehouse / Office - Sharjah**

P.O.Box 44377, Sharjah - UAE,  
Tel: +971 6 5357 007, Fax: +971 6 5357 061  
[dxbqwp@qualitywire.com.bh](mailto:dxbqwp@qualitywire.com.bh)

#### **Sales Office - Qatar**

Logic Real Estate Building, P.O. Box 24692, Doha Jadedd - Qatar  
Tel. : +974 44416175, Fax : +974 44417292  
[sales@qualitywireqatar.com](mailto:sales@qualitywireqatar.com)

#### **Sales Office - Abu Dhabi**

Quality Wire Products OFET Co. LLC  
P.O. Box 36218, Abu Dhabi - United Arab Emirates  
Tel. : +971 2 4912547, Fax : +971 2 4912548  
[bdmqwp@qualitywire.com.bh](mailto:bdmqwp@qualitywire.com.bh)

**Bahrain • Qatar • Saudi Arabia • Oman • Abu Dhabi • Sharjah**

